

FRANKOMA POTTERY

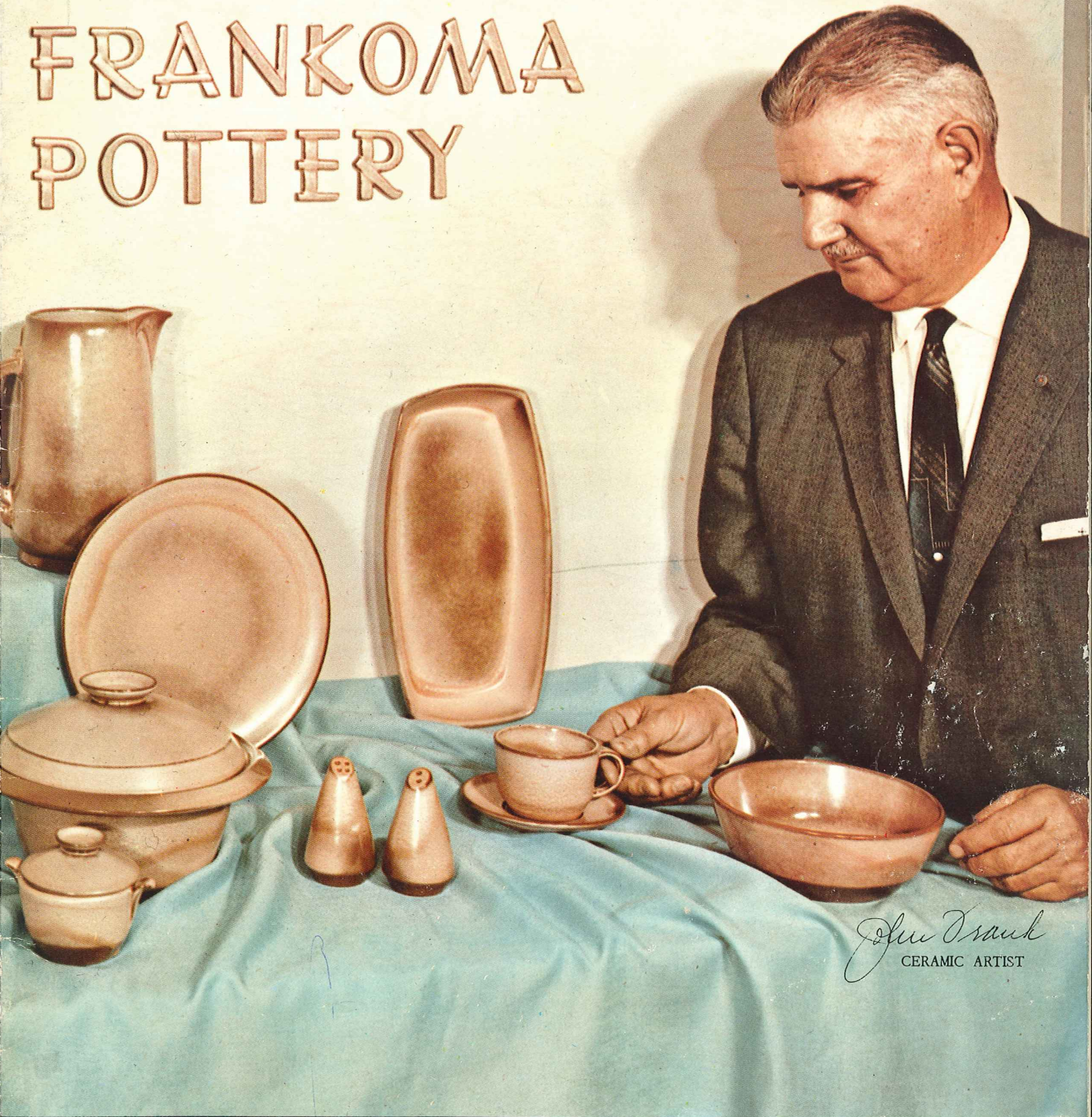

"Westwind" in "Peach Glow"
1963



Brown Satin



Desert Gold



Prairie Green

LAZYBONES Pattern, offered in these 3 colors

The complete set is shown on page 5



Desert Gold



White Sand



Prairie Green

MAYAN-AZTEC Pattern, offered in these 3 colors

The complete set is shown on page 7

Why Frankoma-?

Archeologists say that the Great Southwest was the cradle of the American Indians' culture. As the various tribes dispersed in all directions, their art and potting developed according to the materials and inspirations at hand. Most Indian tribes made pottery of some kind because of the universality of clay, and the ease with which it could be prepared and fashioned into so many useful items.

All tribes of the Southwest were potters, producing grain storage jars, water pots, serving bowls, pitchers, plates and such pieces as they needed to store, prepare and serve their food. Ceremonial objects, including sculptured figures, handled pots and bowls were common. Their decorations were slip painted earthen colors, applied with a brush, or incised designs. Their motifs were taken from daily surroundings — animals, plants, flowers, trees, clouds, hills, weapons, figures, etc.

Our pottery of today differs very little from theirs regarding materials, inspiration and uses. While they were limited as to firing methods and refinement of raw materials, we have added glazes and controlled temperatures and developed complex body compositions. But our common uses for pottery are the same — for the preparation, storage, and serving of foods. Naturally, we have enlarged our scope of uses—flower containers, decorative tile, lamps and other art objects germane to our modern homes.

"Pottery" has been refined, and developed in so many directions that one's selections of dishes, for example, becomes one of discrete choice according to the mode of living one chooses. America's conception of Freedom and Free Enterprise makes it possible for all classes and strata of its people to select a "dinnerware" or "tableware" from these general classes:

- Pottery
- Earthenware
- China
- Fine China
- Porcelain
- Glass — as well as countless other materials.

Frankoma entered the field of ceramics in 1933, utilizing the heritage left it by its predecessors, the Southwest Indians, by choosing POTTERY as its field of endeavor. Our aim was to combine the traditional art of the Indians, the spirit of the American pioneer and the creative tendencies of the youth of the Great Southwest, and mold them into good pottery forms.

John Frank, originator of "Frankoma," came to Oklahoma from Chicago in 1927. His teaching Art and Pottery at the University of Oklahoma and his work with the geological survey — unearthing Oklahoma clay deposits — brought together valuable material for his future venture of "potting." The natural inspiration of the Indians and the opportunities in the new state that had never had a pottery was too much of a challenge to let pass. In 1933 he started a "studio" pottery in Norman, Oklahoma, — equipped with one small kiln, a butter churn for mixing clay, a fruit jar for grinding glazes and a few other crude tools and tables. Help was easy to get in 1933, but it was still necessary to continue teaching until enough ware was produced to prove that

a product could be made of Oklahoma clays that was a contribution to Art and Ceramics and still salable — at a profit.

Resigning his teaching in 1936 he and his wife, Grace Lee, set out on a venture of creating beautiful pottery for everyday living. They felt the need of using Oklahoma clays, if possible, for Oklahoma's first pottery. First a clay from Ada was used, then in 1954 a red burning clay dug at Sapulpa became the basis for all Frankoma ware. In 1938 the "studio" grew into a small factory as it moved from Norman to Sapulpa, where it is now.

Frankoma chose to stay as a "pottery" as it grew, and demanded of itself to make as fine a pottery as could be made considering the limitations of its materials. This means constant research to take advantage of raw materials and processes as they are brought to light.

Pottery enjoys so many advantages over the more "refined" and delicate ceramic wares. Frankoma pottery is manufactured by its unique once-fired process — clay body and colored glaze are fused and fired at the maturing point of the clay, and tempered as it slowly cools. It can be used "indoors — outdoors" because of its ruggedness and durability. It can really "take" the handling of every day use. It is ovenproof and food can be served in the same dish in which it is baked or prepared.

Color is such an indispensable part of today's decor — and nothing allows the wide range of colors and textures in ceramics as pottery. Eating from lovely textured and beautifully colored dishes is a fascinating experience. Some colors such as the "Rutile Art Glazes" which have identified Frankoma's unique tableware around the world, can only be produced on colored earthenware clays. By applying these unique glaze colors in various thicknesses according to pattern and design, the red body shows through the glaze giving a beautiful mottled effect when fired.

No ceramic product seems so close to the artists as pottery — so much so that one can almost trace the potter's fingerprints as he originally formed the body, lips, handles, and designs of a piece. This is an important consideration with Frankoma, for we are artists first, and clay is only the medium of expression.

The uses to which pottery can be put are myriad. Serving bowls double for baking or cobbler dishes, open bowls and platters can be used for hot rolls or upside-down cakes, or keeping the barbecue hot in the oven until ready to serve. Many table service pieces double for table centerpieces or a whole Mexican main course can be served in one. The chop plate can also hang as a wall plate. Pottery keeps foods or drinks hot so much longer than other materials.

Frankoma with its modern plant and latest equipment has been able to maintain its very popular price range in the face of higher materials, taxes and labor costs and the influx of foreign goods; yet, it maintains the original concept that made it accepted as a standard of fine "Pottery" — "every piece should be both useful and beautiful and be a contribution to both art and ceramics." We will continue to do just that, so that every piece will add to your daily pleasure of casual living.

LAZYBONES

PATTERN

AVAILABLE ONLY IN:

- Brown Satin
- Desert Gold
- Prairie Green

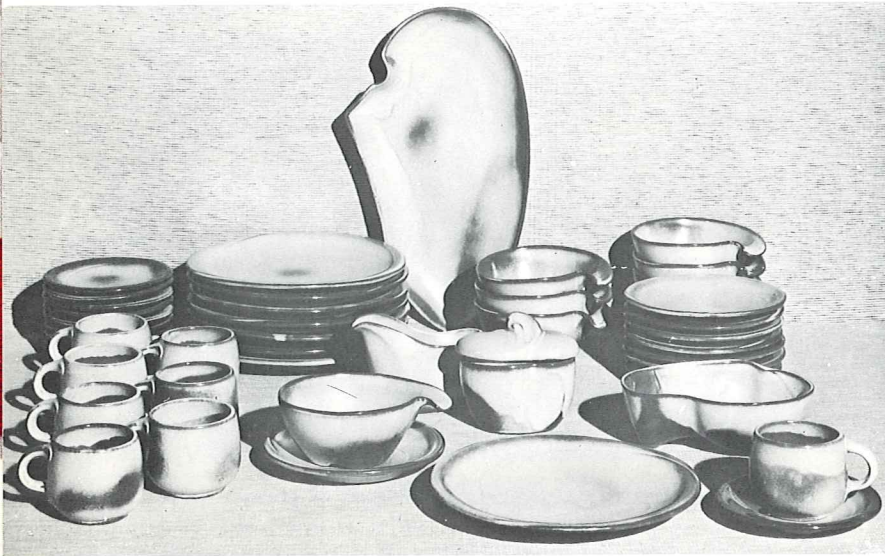

4LS—45 PC. SERVICE SET, BOXED—44.00

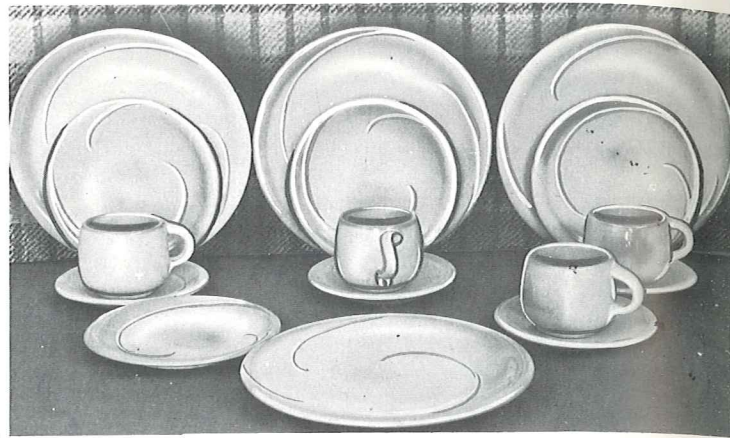

4SS—16 PC. STARTER SET, BOXED—15.00

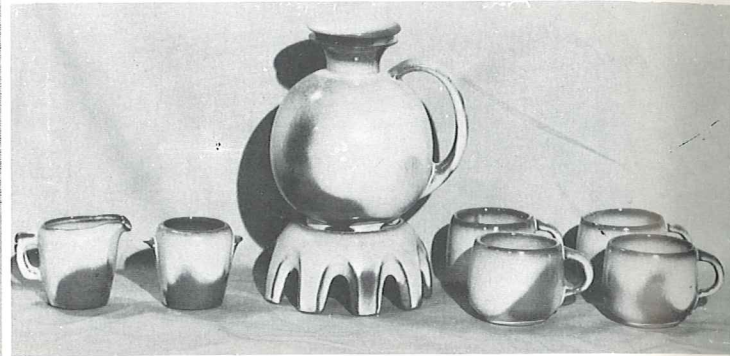

4CS—9 PC. COFFEE SET, BOXED—11.00

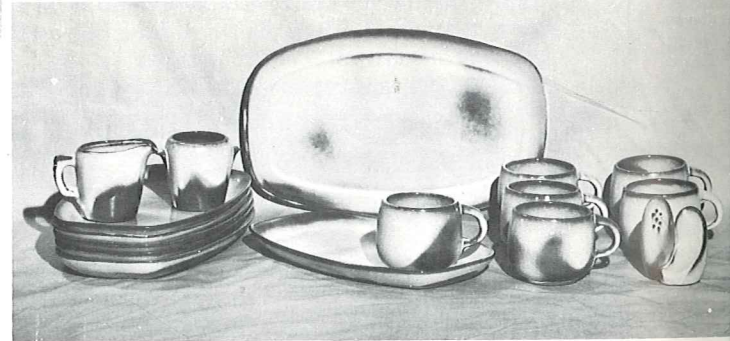

4BB—17 PC. BARBEQUE SET, BOXED—19.00

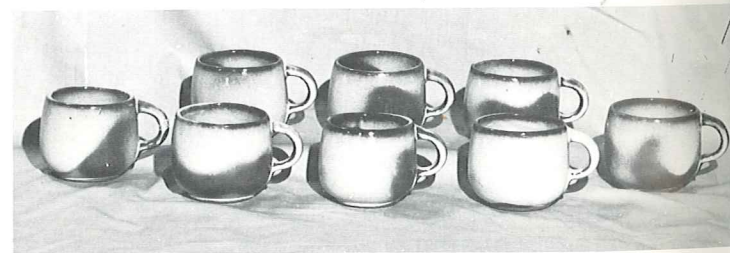

4CC—SET OF 8 COFFEE CUPS, BOXED—6.50

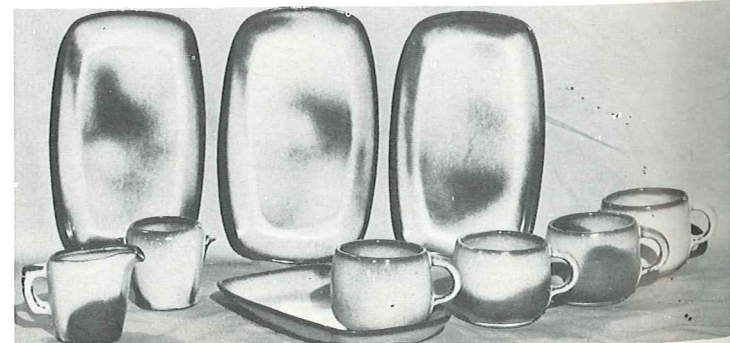

4BS—10 PC. BRIDGE SET, BOXED—10.00

Our American homes are being designed and built so that home makers can take advantage of the many modern conveniences, yet develop their own personalities in color and styling.

The furnishings for these contemporary homes are practical and simplified. They must be selected carefully to preserve a cordial atmosphere, which we all wish for our family and friends.

Frankoma was sensitive to these trends when this new dinnerware was being designed. The atmosphere surrounding LAZYBONES is relaxing, for you are influenced by its free flowing sculptured lines. As you accept the invitation to handle and caress each piece, you will love the way they fit the contour of your hands, for immediately they become a part of you.

Food cooked in Lazybones can go from the oven to the table—and there are so many uses for each piece. They are designed to serve!

Notice the array of Frankoma's colors. They are the gourmet's delight, for they all compliment your food and share in making every meal an occasion. The shapes themselves are both practical and beautiful.

When you set your table with Lazybones, you are set to relax, and enjoy your share of casual living. It will be the "Talk of the Table" with your family and friends.

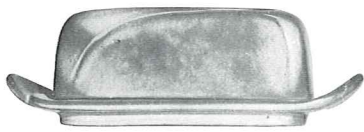

4K—BUTTER DISH—2.00

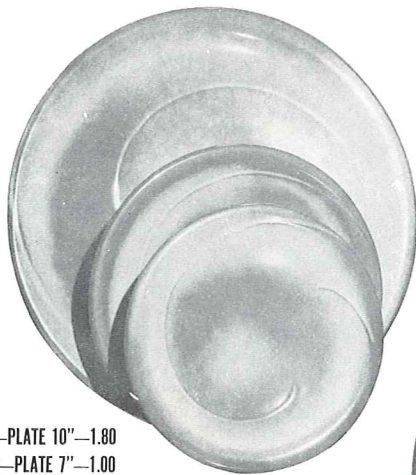

4F—PLATE 10"—1.80

4G—PLATE 7"—1.00

4E—5" SAUCER—.75



4S—BONE DISH 6 1/2"—1.00



4X—CEREAL 16 OZ.—1.00



5L—12 OZ TUMBLER—.75



5LC—6 OZ. JUICE—.75



4C—7 OZ. CUP—.75



4Y—6" SPOON HOLDER—1.00



4H—SALT & PEPPER—1.50



4A—8 OZ. CREAMER—1.00



4B—SUGAR WITH LID—1.50



4M—MUG 18 OZ.—1.20



4Z—6" SOUP—1.00



4V—BAKER 2 QT.—3.00



4P—13" PLATTER—2.50



4N—VEGETABLE 24 OZ.—1.50



4W—BAKER 3 QT.—4.00

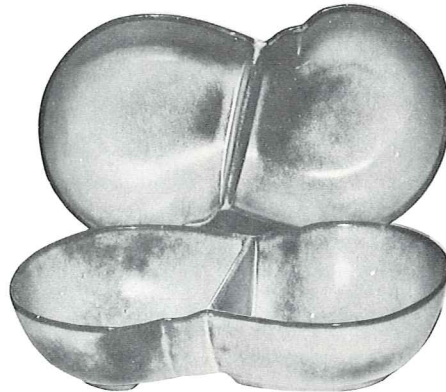

4QD—11" DIVIDED BOWL—2.50

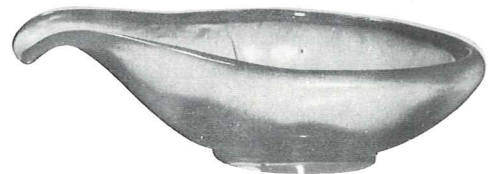

214—SERVICE BOWL 12"—2.50

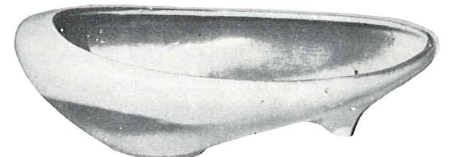

231—SERVICE BOWL 11"—2.50



4WL—5 QT. BAKER—5.00

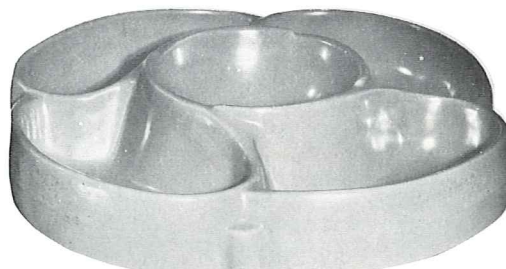

818—5 SECTION LAZY SUZETTE ON BALL BEARING BASE—12"—7.00



4D—PITCHER 2 QUART—3.00

THIS PAGE AVAILABLE IN PRAIRIE GREEN, DESERT GOLD, BROWN SATIN.

SIZES ARE APPROXIMATE AND MAY VARY SLIGHTLY.

MAYAN-AZTEC PATTERN

AVAILABLE ONLY IN:

- Desert Gold
- White Sand
- Prairie Green



7LS—45 PC. SERVICE SET, BOXED—44.00



7SS—16 PC. STARTER SET, BOXED—15.00



7CS—9 PC. COFFEE SET, BOXED—11.00

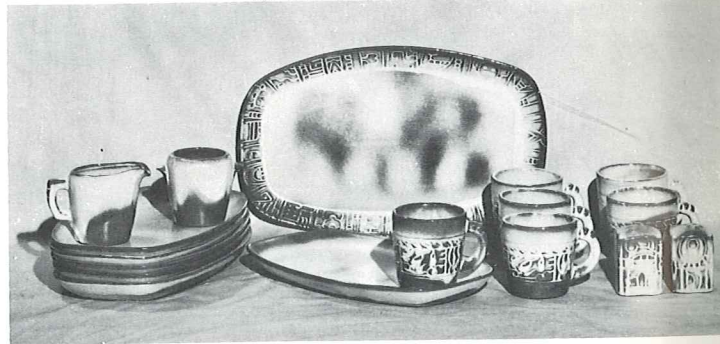

7BB—17 PC. BARBEQUE SET, BOXED—19.00



7CC—SET OF 8 COFFEE CUPS, BOXED—6.50

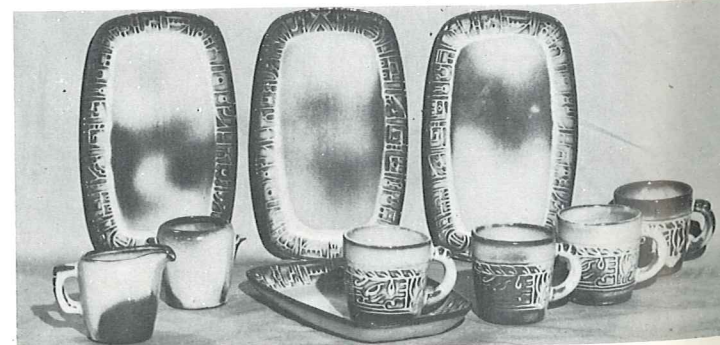

7BS—10 PC. BRIDGE SET, BOXED—10.00

1,000 YEARS . . .

before Columbus "discovered" America, there flourished a civilization in this country whose artistic, social, and religious standards far surpassed any European peoples up to that time. Many archeologists not only compare the art and architecture of the Mayans and Aztecs favorably with that of ancient Egypt, but in many respects prefer their achievements in art importance. THESE were the FIRST Americans.

It is well established that the nucleus of American Indian tribes spread from the Great Southwest region. Our particular interest is in those who went South—the Mayans and Aztecs. They have given to the world some of its richest art treasures. The "golden age" of Mayan Art, in which they developed their pantheon, built their temples, perfected their Arts, social structure and government, occupied the first few centuries after Christ.

The Great Temple in Copan, Yucatan, built to the War Diety, was completed just before the Spanish invasion. The temple compound covered almost a quarter square mile, comprising seventy-eight buildings—a most stupendous achievement and a monument to architectural beauty.

The most widely known of the Mayan and Aztec arts are the numerous hieroglyphs. They were used profusely on buildings, altars, monuments, and other such places, not only for embellishments, but for the recording of information. The decorations on the stairway of Copan alone were composed of over 2,500 different glyphs. Freehand methods prevailed entirely, for their art was their only written language.

Pottery has always evidenced every strata of culture. Fragments of pottery have been found where all other records have been destroyed, even in prehistoric times. Throughout the long history of all Indian tribes, pottery has been the universal art. The pottery of the ancient Southwestern Indians challenges comparison in color, form, and mastery of line with that of the Greeks and Orientals.

It is through the inspiration of this wealth of beauty that FRANKOMA has created its Mayan-Aztec tableware.



7V—BAKER 2 QT.—3.00

- 7FL—PLATE 10"—1.80
- 7F—9" PLATE—1.50
- 7G—PLATE 7"—1.00
- 7E—5" SAUCER—.75



7D—PITCHER 60 OZ.—3.00



7W—BAKER 3 QT.—4.00



7B—SUGAR WITH LID—1.50



7A—6 OZ. CREAMER—1.00



7C—5 OZ. CUP—.75



7M—MUG 14 OZ.—1.20



7WL—5 QT. BAKER—5.00



7U—BAKER 10 OZ.—1.50



7HS—SALT & PEPPER—1.50



7CL—MUG 8 OZ.—1.00



7XO—FRUIT 8 OZ.—.80

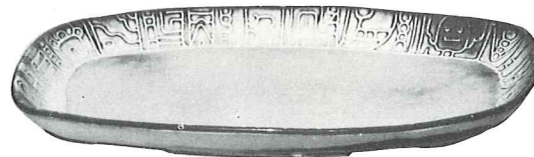

7QS—13" STEAK PLATTER (SHALLOW PLATTER)—2.00

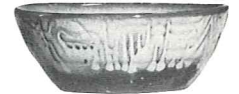

7X—CHILI-SOUP 14 OZ.—1.00



7PS—9" TRAY—1.25



7Q—13" DEEP PLATTER—2.50



7XL—SALAD 20 OZ.—1.25



7T—6 CUP TEA POT—2.50

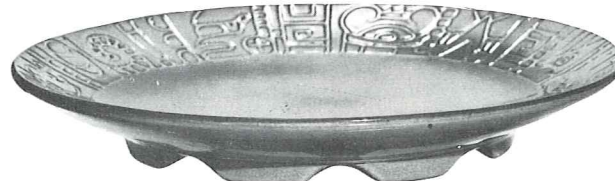

7FC—15" CHOP PLATE—7.00



7N—1 QT. VEGETABLE BOWL—1.50



7P—17" DEEP PLATTER—5.00



7J—TEAPOT 2 CUP—1.50

THIS PAGE AVAILABLE IN PRAIRIE GREEN, DESERT GOLD, WHITE SAND.

SIZES ARE APPROXIMATE AND MAY VARY SLIGHTLY.

Westwind

PATTERN

AVAILABLE ONLY IN:

- Peach Glow
- Woodland Moss
- Prairie Green



6LS—45 PC. SERVICE SET, BOXED—44.00

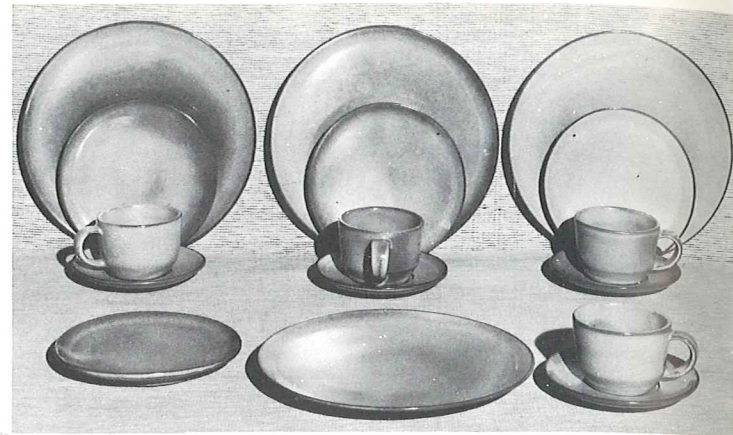

6SS—16 PC. STARTER SET, BOXED—15.00

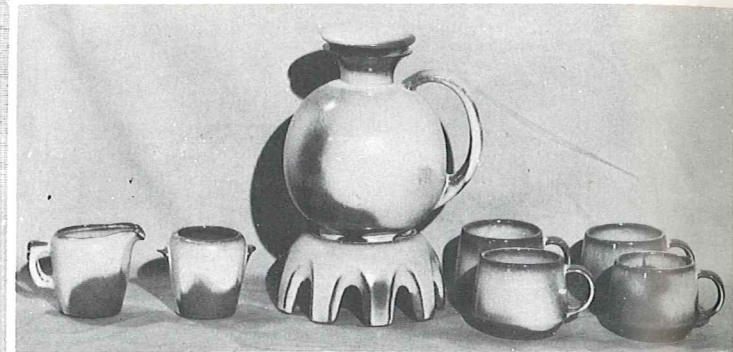

6CS—9 PC. COFFEE SET, BOXED—11.00

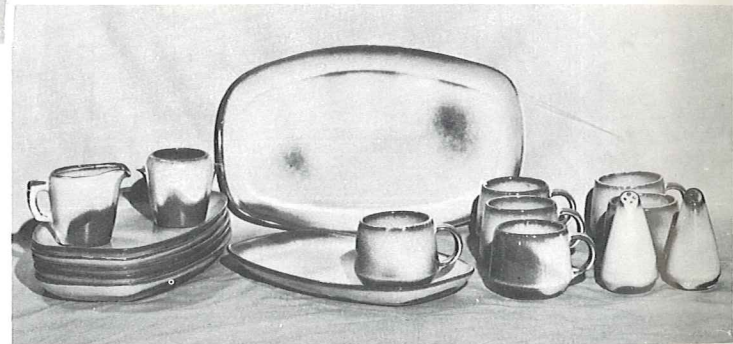

6BB—17 PC. BARBEQUE SET, BOXED—19.00

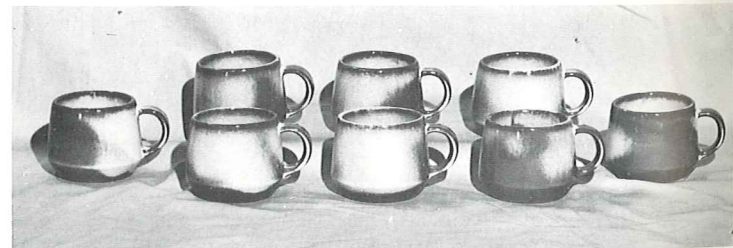

6CC—SET OF 8 COFFEE CUPS, BOXED—6.50

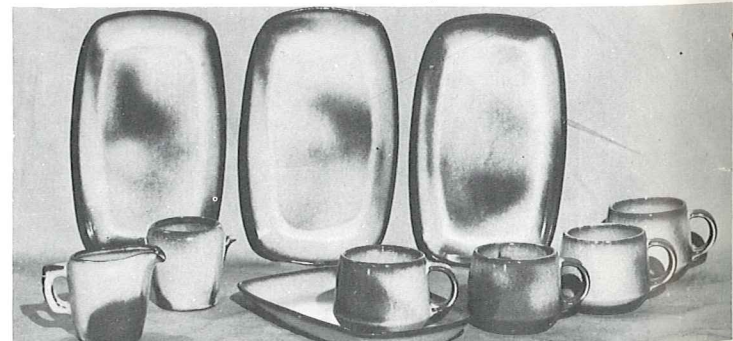

6BS—10 PC. BRIDGE SET, BOXED—10.00

SIMPLICITY in its truest form — that's "Westwind." The carefully broken line of the shallow coupe shape is the key to the pattern. The simple unbroken line of the cup handle, with its broad thumb rest, combines grace and security.

The large and small open bakers have rolled rims for safety and ease of handling. Cleaning is no task. Much care is exercised in making these "easy-grip" knobs on the lids. This oven-to-table pottery is truly the gourmet's delight.

The homemaker today appreciates the warm, cordial earthen colors in this unique pottery. Its waxy textures are so lovely to the touch. Such tableware should be selected for its artistic qualities as well as its serviceability.

"Westwind," with its basic simple lines, permits freedom in expression of personality which is so important in smart contemporary homes. You'll LOVE "Westwind"—and, of course, it is all ovenproof.

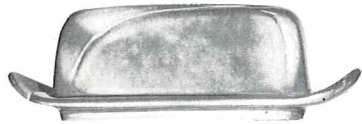

4K—BUTTER DISH—2.00

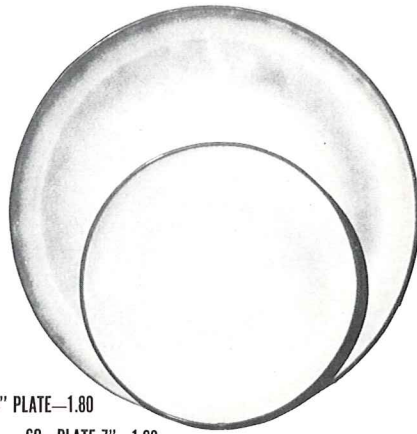

6F—10" PLATE—1.80

6G—PLATE 7"—1.00



6B—SUGAR WITH LID—1.50



6A—9 OZ CREAMER—1.00



6V—BAKER 2½ QT.—4.00



6C—6 OZ. CUP—.75

6E—5" WELLED SAUCER—.75

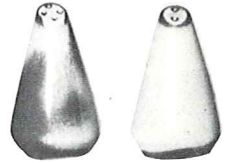

6H—SALT & PEPPER—1.50



6CL—DOUBLE COFFEE—1.00

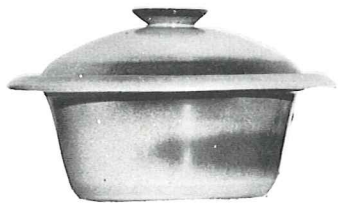

6VS—1½ QT. BAKER—3.00



5LC—6 OZ. JUICE—.75



5L—12 OZ TUMBLER—.75



81—1 QT. PITCHER—1.80



80—2 QT. PITCHER—2.50



6U—18 OZ. BAKER-FOR-TWO—2.00
A COVERED CANDY DISH

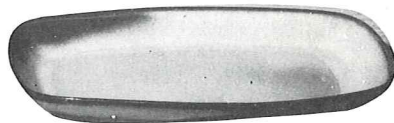

5PS—9" TRAY—1.25

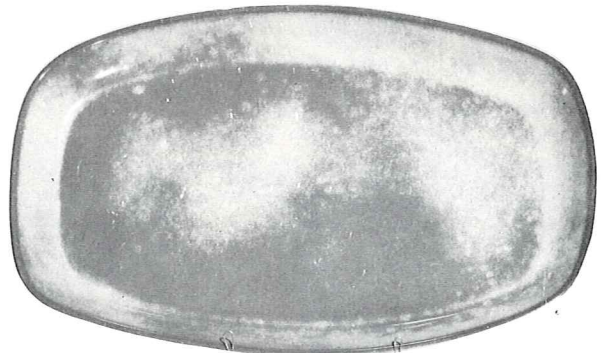

5QS—13" STEAK PLATE (SHALLOW PLATTER)—2.00

6P—STEAK PLATE 11"—1.60



6X—CHILI-SOUP 14 OZ.—1.00

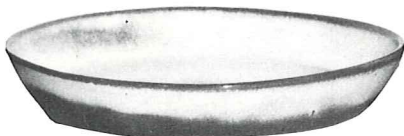

91—10" BAKING DISH—2.00

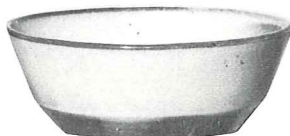

6N—1 QT. BOWL—1.50

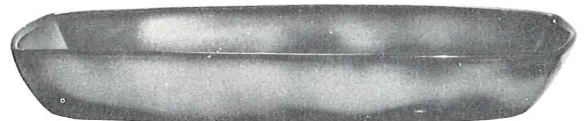

5Q—13" DEEP PLATTER—2.50

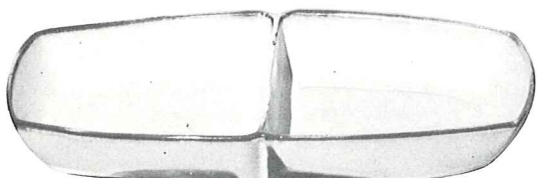

5QD—13" DIVIDED BOWL—2.50

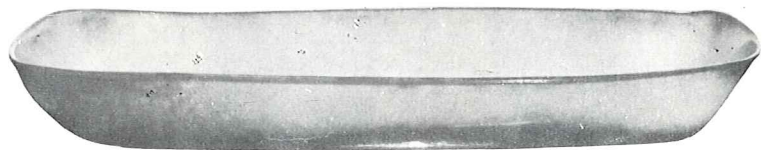

5P—17" DEEP PLATTER—5.00

THIS PAGE AVAILABLE IN PEACH GLOW, PRAIRIE GREEN, WOODLAND MOSS. SIZES ARE APPROXIMATE AND MAY VARY SLIGHTLY.

PLAINSMAN PATTERN

AVAILABLE ONLY IN:

- Woodland Moss
- Desert Gold
- Brown Satin
- Prairie Green



5LS—45 PC. SERVICE SET, BOXED—44.00

For thousands of years men have gloried in creating "atmosphere" around their favorite sport — eating. Harmonious and beautiful surroundings not only add to the pleasure of eating but make it a healthier pastime. We still lavish all we possibly can on our banquets and feasts, for we love to eat.

Men have always managed to devise some sort of receptacle to hold food, either raw or prepared, and the quality and value of his utensils depend more on his love of beauty and ability to create than the size of his purse. Of the many materials used throughout the centuries, in all countries of the world — iron, copper, brass, stone, wood, silver, and even gold, ceramics has remained the favorite of all eating vessels. Since the acceptance of "whiteware" in the sixteenth century, most fine tables have been set with "dinnerware" or "china." This is sometimes a white earthenware, or a compounded china body, or even a translucent true porcelain. Its quality depends on the selection and handling of the materials plus its Art value expressed in line, form and color.

Today, from the crudest earthenware to the finest porcelain, we still choose CERAMICS of some kind for our table. Although we would not eliminate "whitewares," we love our modern pottery tableware. Why not? It is gay, happy, and colorful, and surely fits into our modern mode of living. It is with this in mind that we have created FRANKOMA TABLEWARE.

For one design we have gone to the Great Plains of the Southwest and offer you the "PLAINSMAN" pattern. Its well chosen, simple lines and sturdy shapes create an atmosphere befitting its heritage. It is most appropriate "for fun or fashion." Every piece is oven-proof.

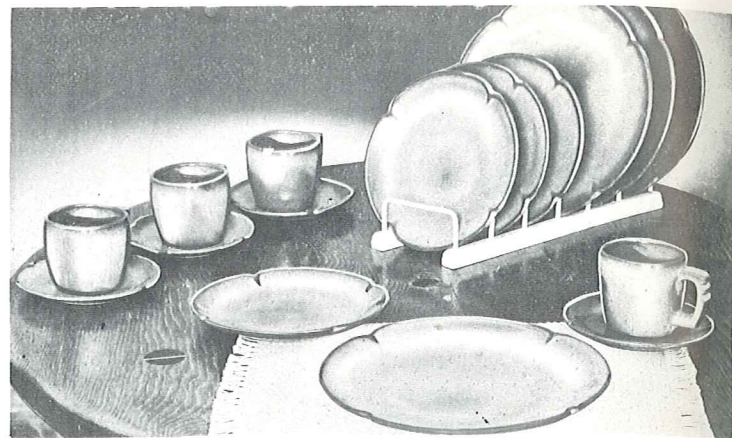

5SS—16 PC. STARTER SET, BOXED—15.00



5CS—9 PC. COFFEE SET, BOXED—11.00

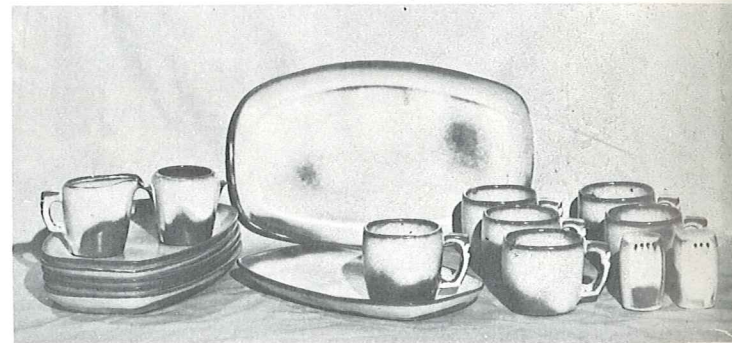

5BB—17 PC. BARBEQUE SET, BOXED—19.00



5CC—SET OF 8 COFFEE CUPS, BOXED—6.50

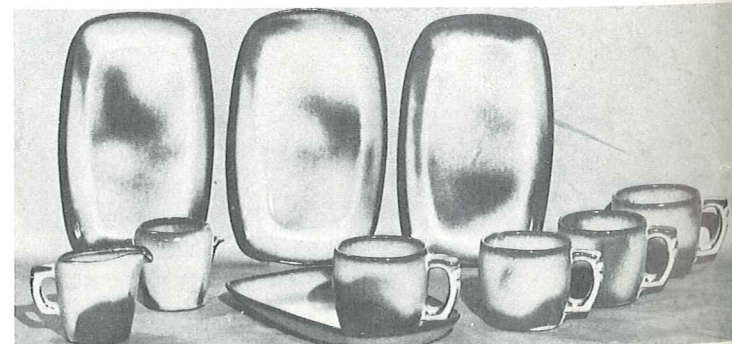

5BS—10 PC. BRIDGE SET, BOXED—10.00

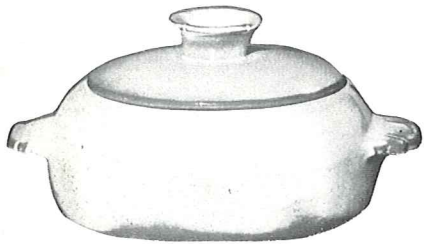

5V-BAKER 2 QT.—3.00

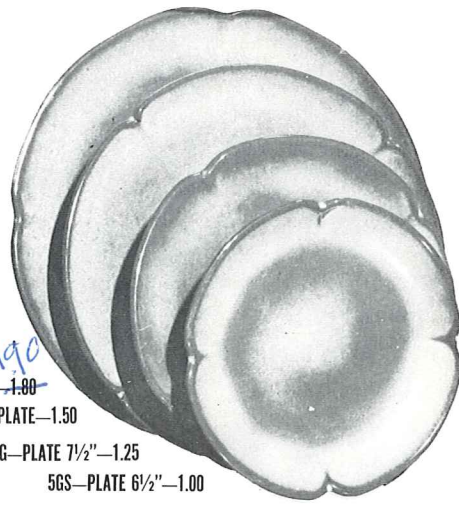

5F-PLATE 10"^{1.90}—1.80

5FS-9" PLATE—1.50

5G-PLATE 7 1/2"—1.25

5GS-PLATE 6 1/2"—1.00

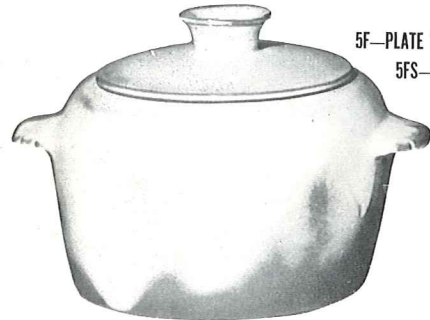

5W-BAKER 3 QT.—4.00

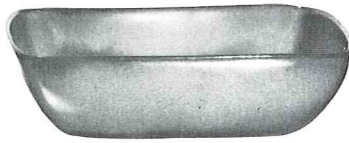

5NS-9" VEGETABLE—2.00



5LC-6 OZ. JUICE—.75



5DC-DEMITASSE CUP—.65

5DE-DEMITASSE SAUCER—.65



5A-12 OZ. CREAMER—1.00



5CL-MUG 12 OZ.—1.00



5B-SUGAR WITH LID—1.50



5C-8 OZ. CUP—.75

5E-5 1/2" SAUCER—.75

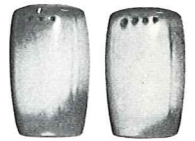

5HS-SALT & PEPPER—1.50



5WL-5 QT. BAKER—5.00

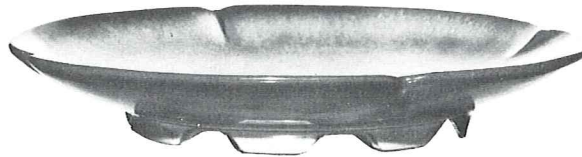

5FC-15" CHOP PLATE—7.00



5L-12 OZ. TUMBLER—.75



5M-MUG 16 OZ.—1.20

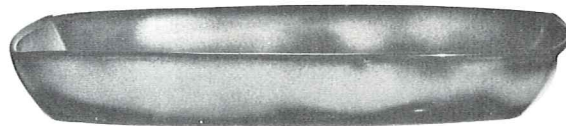

5P-17" PLATTER—5.00

5Q-13" PLATTER—2.50



5DB-6 OZ. SUGAR—.75



5DA-6 OZ. CREAMER—.75

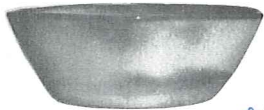

5XL-BOWL 20 OZ.—1.25

5X-CEREAL 14 OZ.—1.00

5XS-FRUIT 9 OZ.—.80

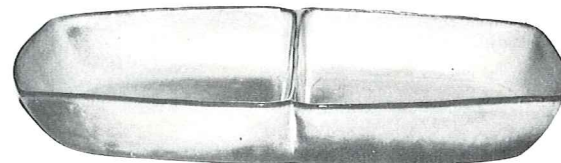

5QD-13" DIVIDED BOWL—2.50



5TL-TEAPOT, 12 CUP—4.00



5ND-9" CHEESE DIP—2.50

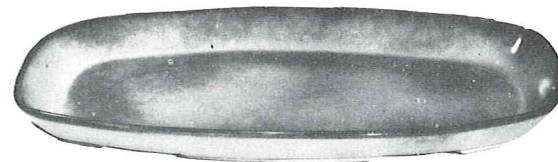

5QS-13" PLATTER—2.00

5PS-9" TRAY—1.25

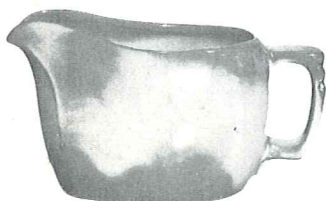

5S-20 OZ. GRAVY BOAT—1.50



5N-4 1/2 QT. BOWL—5.00



5T-6 CUP TEAPOT—2.50



5D-3 QT. PITCHER—3.50

WAGON WHEEL

PATTERN

AVAILABLE ONLY IN:

Desert Gold
Prairie Green



94LS—45 PC. SERVICE SET, BOXED—44.00

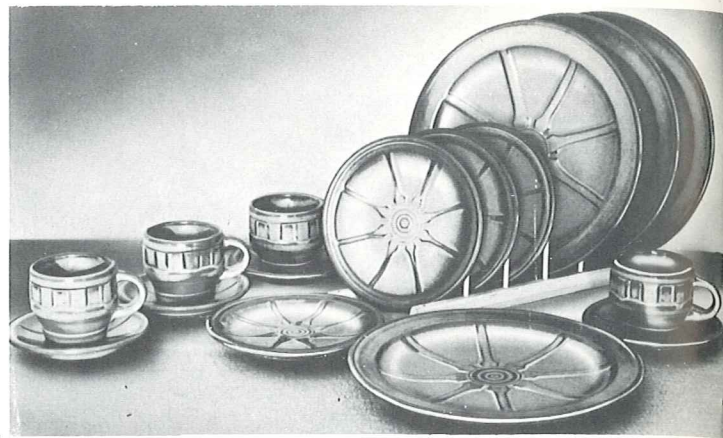

94SS—16 PC. STARTER SET, BOXED—15.00



94CS—9 PC. COFFEE SET, BOXED—11.00

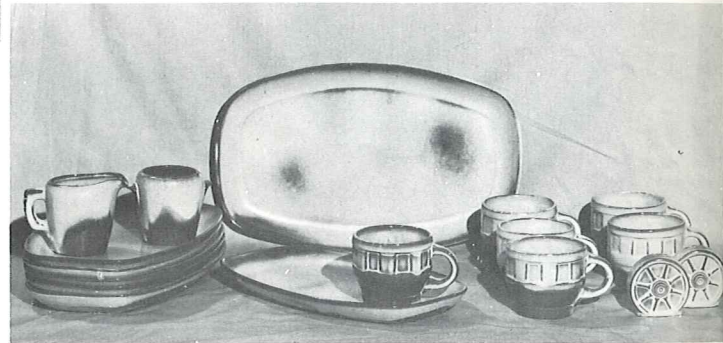

94BB—17 PC. BARBEQUE SET, BOXED—19.00

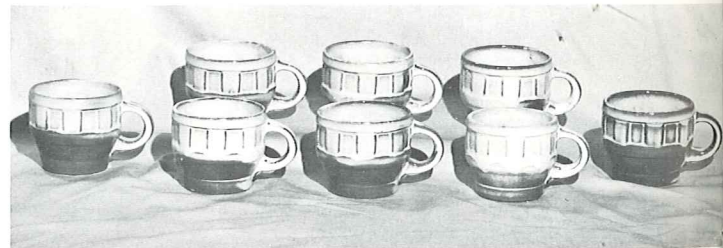

94CC—SET OF 8 COFFEE CUPS, BOXED—6.50

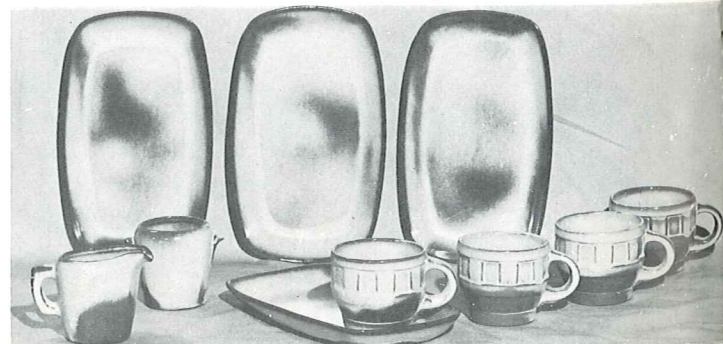

94BS—10 PC. BRIDGE SET, BOXED—10.00

THE ROMANCE OF THE WEST lives on with our WAGON WHEEL Pottery! The pitchers are quaint and practical. The cup is the hub of a wheel, and the "good luck" horseshoe makes the handles for the baker. There are bands of cattle brands on the platters and bowls. The whole set is an application of the fine designs one can find on any ranch.

A most colorful part of the history of the Southwest is the cattle industry, and the rancher's "coat of arms" is his "cattle-brand." The covered wagon, "wagon wheels," horses, the cowboys, cattle, the "little dogies", and above all, the "cattle-brand" are symbols of this natural industry. The cattle-brand is the symbol of the rancher, and it identifies his proudest possessions. It is the family trademark, handed down from generation to generation.

Many of these brands are fine designs, and most of them have a definite meaning. Some are the initials of the owner, others may refer to hills on the ranch, the number of acres he owns, the number in the family, his monogram, key, a hat, or any one of a thousand items of interest. Each brand is usually registered in the county in which it is used.

We are proud to take this opportunity to eulogize these pioneers of the Southwest, and include a number of these brands in decorating some of the pieces of our WAGON WHEEL set. Every piece is oven-proof.



454-6" ASH TRAY & CANDLE HOLDER-1.50

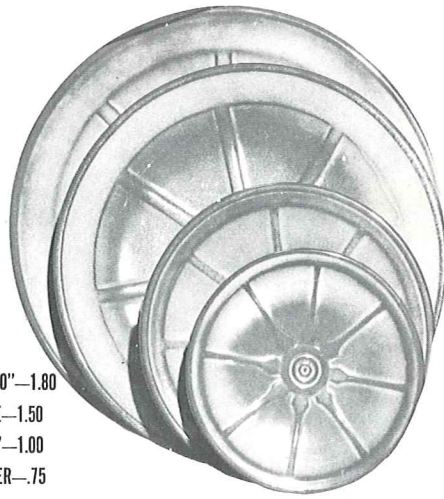

94FL-PLATE 10"-1.00
94F-9" PLATE-1.50
94G-PLATE 7"-1.00
94E-5" SAUCER-.75

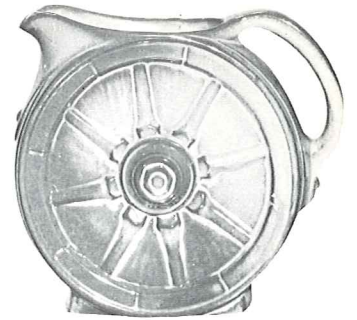

94D-2 QT. PITCHER-2.50



94H-SALT & PEPPER-1.50



94M-MUG 16 OZ.-1.20

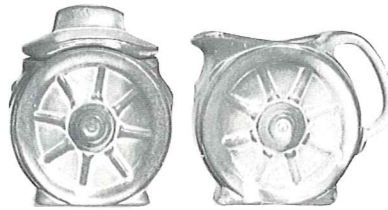

94B-SUGAR WITH LID-1.50 94A-8 OZ. CREAMER-1.00



94C-5 OZ. CUP-.75



94L-12 OZ. TUMBLER-.75

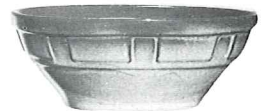

94XL-BOWL 20 OZ.-1.25

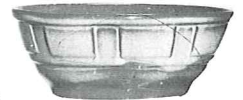

94X-CEREAL 14 OZ.-1.00



94V-BAKER 2 QT.-3.00

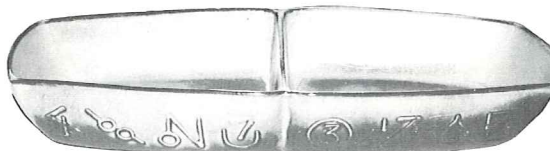

94QD-13" DIVIDED BOWL-2.50

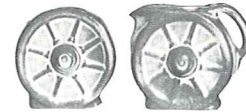

510 & 560-CREAMER & SUGAR-1.30



94XO-DESSERT 6 OZ.-.80



94W-BAKER 3 QT.-4.00

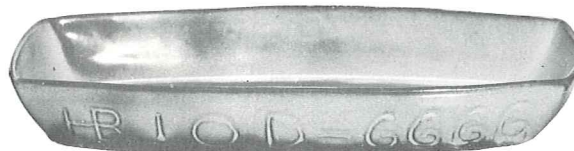

94Q-13" PLATTER-2.50



94N-1 QT. VEGETABLE BOWL-1.50



94P-17" PLATTER-5.00

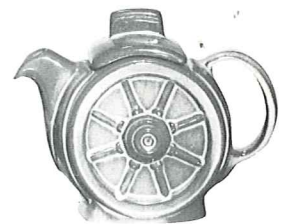

94J-TEAPOT 2 CUP-1.50



94WL-5 QT. BAKER-5.00



94FC-15" 7-SECTION SUSAN WITH BALL BEARING BASE-7.50



94T-6 CUP TEA POT-2.50

THIS PAGE AVAILABLE IN PRAIRIE GREEN AND DESERT GOLD.
SIZES ARE APPROXIMATE AND MAY VARY SLIGHTLY.

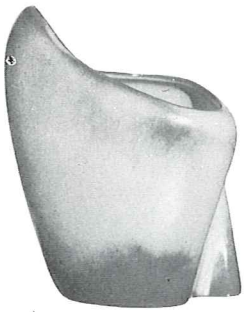

6-7" FREE FORM VASE—1.80



233—ROUND BOWL—1.80



54-6" SHELL VASE- 1.50



190-6" WALL VASE—1.00



58—FREE FORM - THREE LEVEL—4.00



F34-8" RICE BOWL—2.00



59—CANTEEN 6½"—1.80



F29-6" DRAPERY VASE—1.50



F35-7" PEDESTALLED VASE—2.00



57S-6" CORNUCOPIA—1.00



F52-7" PEDESTALLED URN—2.50



F33-7" FLUTED PLANTER—2.00



OLD FASHIONED PITCHER SET
F30A-5½" PITCHER—1.50
F30B-7" BOWL—1.50



40A—SMALL PITCHER—1.00
40B—BOWL—1.00



7-7" VASE—1.50



57-7" CORNUCOPIA—1.50

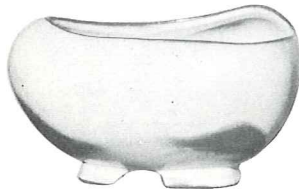

234—FOOTED FREE FORM BOWL—2.00



29-8" BOTTLE—1.00



43-8" BUD VASE—1.00



28-6½" BUD VASE—1.00

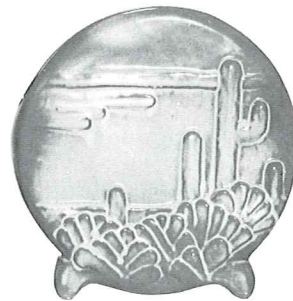

4-7" CACTUS VASE—1.80

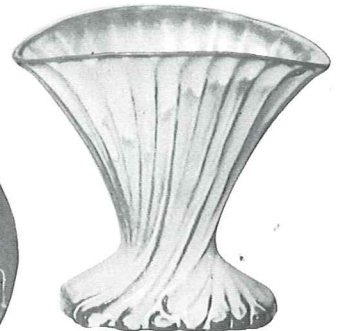

19-7" FAN VASE—2.00



71-10" LEAF HANDLED VASE—3.50



55-5" ROUND JAR—1.50



22S-5" FOOTED ROUND VASE—1.00



22-7" FOOTED ROUND VASE—2.00



52—URN 8"—3.00

THIS PAGE AVAILABLE IN ALL COLORS, BLACK & WHITE.

SIZES ARE APPROXIMATE AND MAY VARY SLIGHTLY.



227-17" LEAF-5.00



226-11" LEAF-2.00

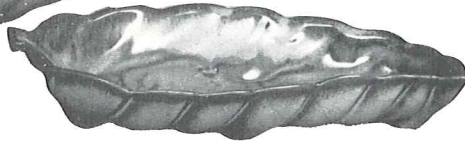

225-7" LEAF-1.00

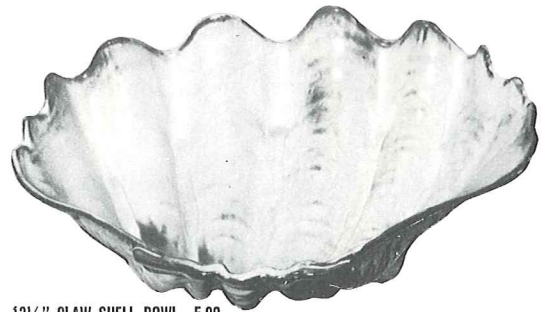

T10-13 1/2" CLAW SHELL BOWL-5.00

T10T-IN GREEN, MOSS AND BROWN WITH WHITE LINING-6.00

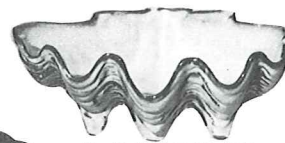

T9-7" SHELL BOWL-1.50

T9T-IN GREEN, MOSS AND BROWN WITH WHITE LINING-2.00



223-6" FOUR LEAF CLOVER-1.00



205-BOWL 10"-1.80

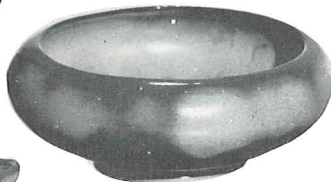

212-8" ROUND BOWL-1.50



473-6 1/2" SHELL TRAY-1.00

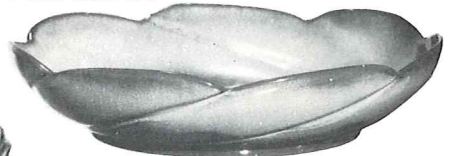

218-12" SCALLOPED BOWL-2.50



231-BOWL 11"-2.50



203-10" CACTUS BOWL-2.00

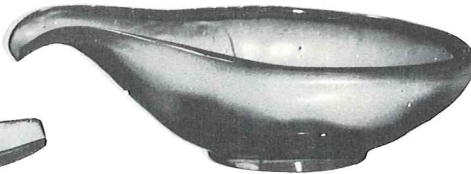

214-BOWL 12"-2.50



201-BOWL 9"-1.80

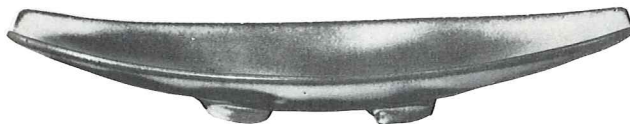

F88-15" SHALLOW BOWL-3.00



202-11" BOWL-2.00

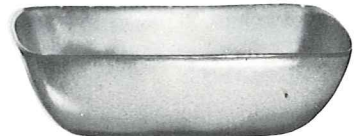

5NS-9" SQUARE BOWL-2.00

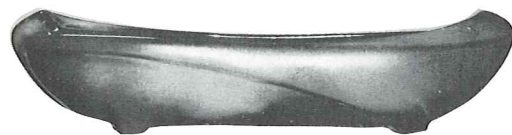

45-12" OBLONG PLANTER-2.00



224-8" ROUND BOWL-2.00



211-12" CRESCENT BOWL-2.50

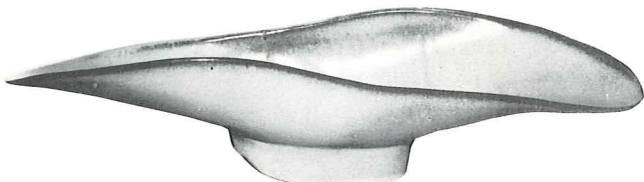

F91-17" FREE FORM BOWL-5.00



217-18" FREE FORM BOWL-5.00

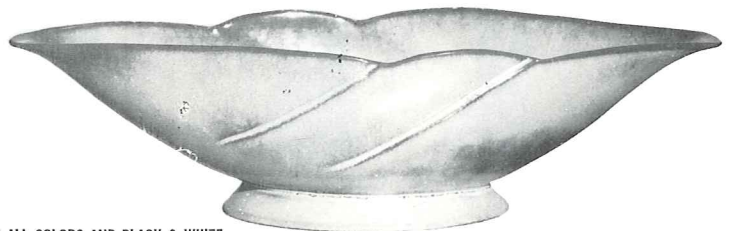

219-18" BOWL-5.00

THIS PAGE AVAILABLE IN ALL COLORS AND BLACK & WHITE. SIZES ARE APPROXIMATE AND MAY VARY SLIGHTLY.



77A-17" FIRESIDE PITCHER-10.00



77-17" FIRESIDE VASE-10.00

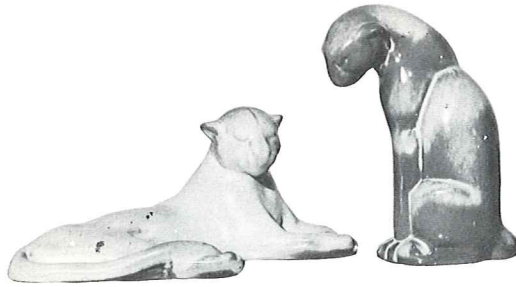

116-RECLINING PUMA-3.50

114-7" SEATED PUMA-1.50



113-13" FAN DANCER-5.00



433-PLANTER BOOT BOOKENDS-5.00 PR.



133-6 1/2" BOOT-1.50



305-SINGLE CANDLE HOLDER-2.00 PR.



304-DOUBLE CANDLE HOLDER-2.00 PR.



F55-17" WINE BOTTLE-3.50



118T-TRAGEDY WALL MASK-2.50



118C-COMEDY WALL MASK-2.50



T7-4" COCONUT PLANTER-1.00



T3-12 OZ. TIKI TUMBLER-1.50



T2-6 1/2" BAMBOO TUMBLER-1.00



306-TRIPLE CANDLE HOLDER-3.00 PR.



208-MALLARD PLANTER 11"-3.50



228-SWAN PLANTER 7 1/2"-1.80

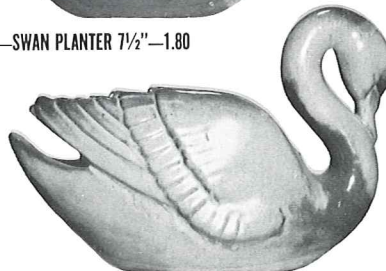

229-9" SWAN-3.50



78-19" DECORATIVE VASE-10.00



78A-19" DECORATIVE PITCHER-10.00



H-MARE & COLT, 12"-2.50



C-COYOTE, 12"-2.50



M-INDIAN MAID, 12"-2.50

MADE ONLY IN RUBBED WOOD FINISH

THIS PAGE AVAILABLE IN ALL COLORS, INCLUDING BLACK AND WHITE.

SIZES ARE APPROXIMATE AND MAY VARY SLIGHTLY.



833—24 OZ.—1.50



803—HONEY JAR W/LID—1.50



8—24 OZ.—1.50



831—16 OZ.—1.50



835—24 OZ.—1.50

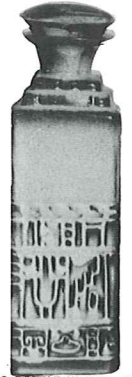

7JH—AZTEC BOTTLE W/LID—2.00
7JH—AZTEC BOTTLE 24 OZ.—1.50

JUGS FOR HONEY—SYRUP—SALAD DRESSING, ETC.—WITH CORKS.



504—SUGAR 2"—.65



553—CREAMER 2"—.65



167—HORSE SHOE—.65

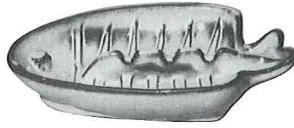

T8—FISH—7"—1.00

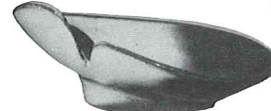

466—FREE FORM—7"—1.00



467—FREE FORM ASHTRAY—.65



510—SUGAR 2"—.65



560—CREAMER 2"—.65



513—CLOVER LEAF 3"—.65



512—MINIATURE LEAF 4"—.65



468—FISH ASHTRAY 4"—.65

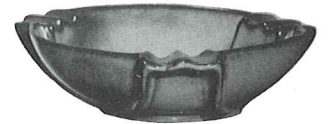

458—ROUND ASHTRAY—2.00



550—PITCHER 2"—.65



555—PITCHER 2"—.65

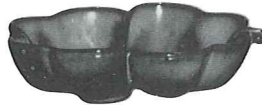

223—6" CLOVER LEAF—1.00



463—ARROWHEAD ASHTRAY 4"—.65



472—4" SHELL—.65

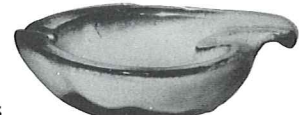

452—FREE FORM—7"—1.50



507S—BOOTS ON THONG—1.50



507—BOOT 3"—.65



469—SAFETY ASHTRAY—.75



470—AZTEC ASHTRAY 3½"—.65

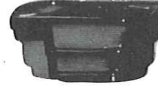

456—ASHTRAY—.75

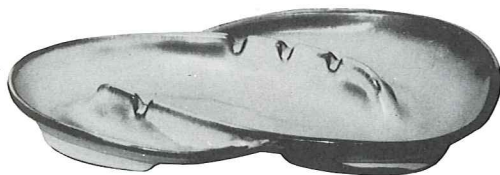

F203—TEAR DROP—13½"—3.00

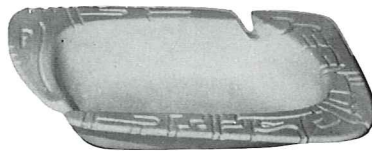

471—AZTEC—9"—2.00



464—SQUARE—10½"—5.00

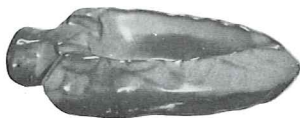

453—ARROW HEAD—7"—1.00



F204—RYTHM ASH TRAY—10"—2.50

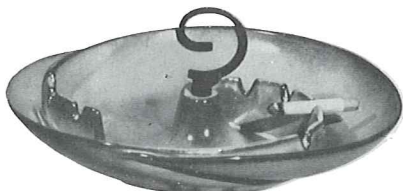

30—WITHOUT HANDLE—3.00 30T—10" ROUND ASH TRAY—3.50

ASH TRAYS



36M—WITH MAGAZINE RACK—8.50



34—10½" SQUARE—7.50



36—12" TRAY ON STAND—7.50

34M—SAME STAND WITH SQUARE TRAY—8.50

34—10½" TRAY ONLY—5.00

36—12" TRAY ONLY—5.00

THIS PAGE AVAILABLE IN ALL COLORS, BLACK & WHITE.
SIZES ARE APPROXIMATE AND MAY VARY SLIGHTLY.

FOR SMOKERS AND SNACKERS, ANYWHERE: WITH REFRESHMENT CORNERS: ON STURDY WROUGHT IRON.



820-15" CHOP PLATE-7.00



20-6" BUD VASE-1.00



94TRC-6" CATTLE BRAND-1.00
TRIVETS



94TRH-6" HORSE SHOE-1.00

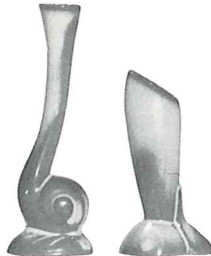

31-BUD VASE 6"-.75 32-BUD VASE 4"-.65



82-COFFEE CARAFE COMPLETE-6.00
82-CARAFE & LID ONLY-4.00



7TR-6" CHEROKEE ALPHABET-1.00



93-24 OZ. PITCHER-1.80
90C-TUMBLER 3 OZ.-.65
93-JUICE SET, 7 PIECES-5.00



87-1 QT. PITCHER-1.80



25-TEA-2.50



25-COFFEE-3.00



25-SUGAR-3.50



25-FLOUR-4.00

CANNISTER SET-4 PIECES-12.00



A8-8 1/2" JARDINIERE FOR 6 1/2" POT-2.00



826-6" BOWL-1.00



B3-4" CORK BARK PLANTER-1.00

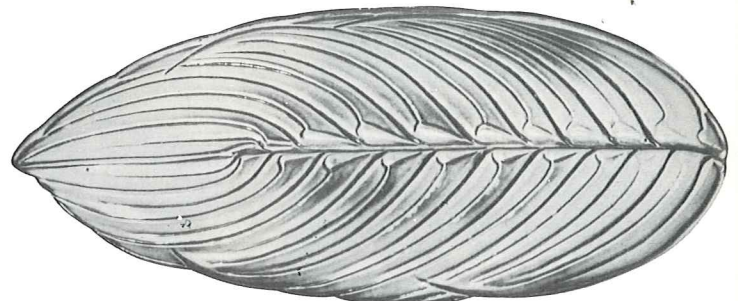

T11-17" PALM LEAF TRAY-5.00

AVAILABLE ONLY IN GREEN, GOLD, MOSS & BROWN.

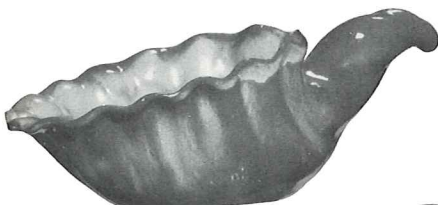

222-12" CORNUCOPIA-2.50



14-8" PLANTER-1.50



215-15" CORNUCOPIA-7.00

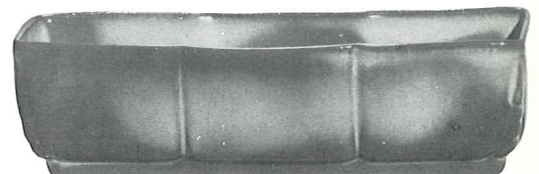

15-12" PLANTER-2.50

THIS PAGE AVAILABLE IN ALL COLORS AND BLACK & WHITE. SIZES ARE APPROXIMATE AND MAY VARY SLIGHTLY.



Woodland Moss



Peach Glow



Prairie Green

WESTWIND Pattern, offered in these 3 colors

The complete set is shown on page 9

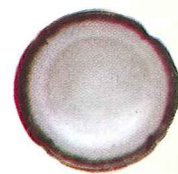

Woodland Moss



Desert Gold



Prairie Green



Brown Satin

PLAINSMAN Pattern, offered in these 4 colors

The complete set is shown on page 11

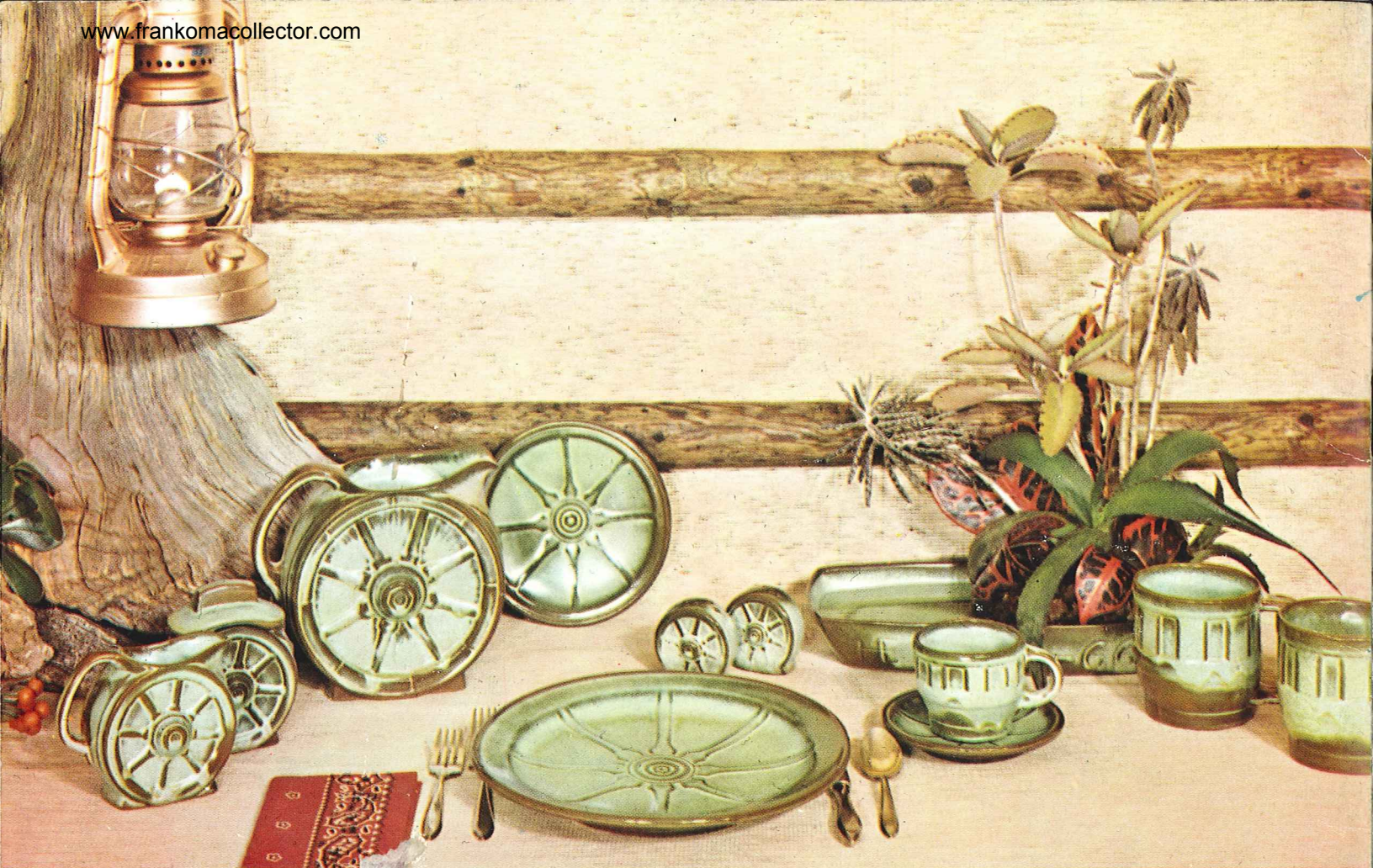

WAGON WHEELS Pattern, offered in these 2 colors

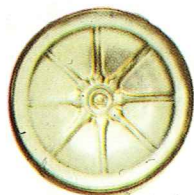

Prairie
Green



Desert
Gold

The complete set is shown on page 13

FRANKOMA is ovenproof but does not claim to be flameproof. You will find it very durable and serviceable wherever china or pottery can be used. It is designed to be entirely satisfactory and we would appreciate letting the factory know of any deviation from this standard.

You are a welcomed guest at the factory any time. Should you come during working hours, we will be glad to conduct you through the plant to see FRANKOMA made. Prices subject to change without notice.

FRANKOMA POTTERY

